

# Slide & Go Clip System

For technical questions not answered in this document, please visit our website [www.trunorthdeck.com](http://www.trunorthdeck.com)  
or call 1-905-256-0022.

TruNorthDeck is designed to work with a hidden fastener system to control expansion and contraction (see figure 1 below), therefore it is important to install the product according to manufacturer's recommended installation instructions. Failure to follow installation instruction will void product warranty. For comprehensive deck installation instructions refer to TruNorthDeck website.

Note: Enviroboard hollow profile is recommended for residential applications only and is highly recommended to be installed on 12" O.C. spans for maximum customer satisfaction. 16" OC span installation is covered under warranty as well, when installed in accordance with manufacturer's specifications.

Accuspan deck boards can be installed at 16" O.C. spans.

## Parts Included

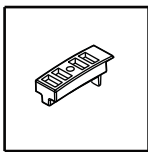

Clip

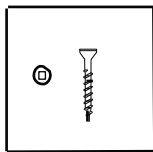

Screw

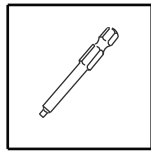

Driver Bit

## Parts Not Included

- 3/8" Hole plugs with screws
- 2 1/2" Composite Deck screws

## Tools Required

- Drill
- 3/8" Drill Bit
- Chalk line

## Installing First Board

Note: First board must be straight and secured

**1a Enviroboard Deck Board** - is highly recommended to be installed on 12" O.C. spans for maximum customer satisfaction. 16" OC span installation is covered under warranty as well, when installed in accordance with manufacturer's specifications.

Position first board along the edge of ledger board and secure to each joist by drilling a 3/8" hole through the first wall of the board then screw the bottom wall of the deck board to the ledger using a #8 pan head screw and capping the hole with a plug.

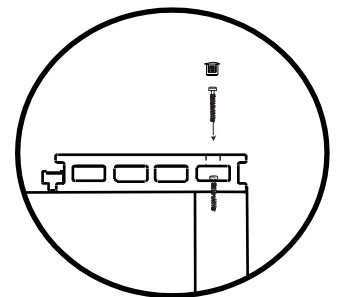
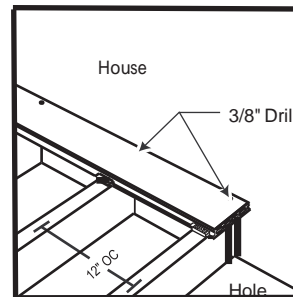

1 a

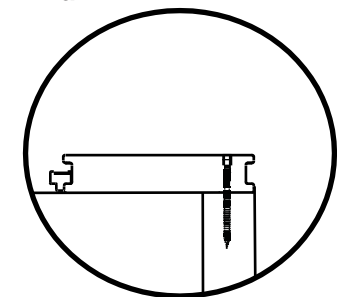
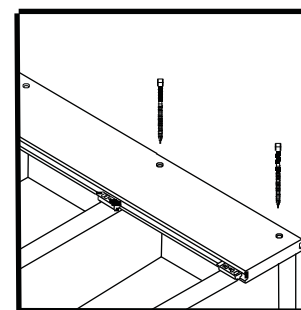

## 1b Accuspan Deck Board

Position first board along the edge of ledger board and secure to each joist with a 2 1/2" composite deck screw, it is recommended to predrill the holes to prevent the composite board from cracking and mushrooming of material at the screw head.

**2** Position a Hidden Fastener clip at each joist on the grooved edge of the board and secure it loosely with clip screw. Securing the clip loosely will allow the next board to slide under the clip smoothly.

Continue positioning deck boards and securing to the joist with Slide and Go Fastener Clips. After a few boards are laid down go back and tighten clip screw.

Note: Do not over torque.

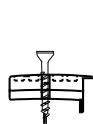

Loose

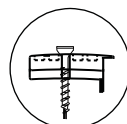

Good

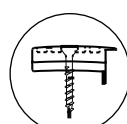

No Good

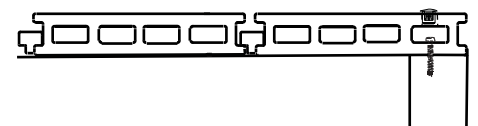

**Note: Over torquing clips screws will result in voiding the warranty.**

## Clip Torquing Guidelines

Proper torquing of the fastening clips is important to ensure your deck boards will expand and contract.

Overtorquing will drive the clip screw into the clip and restrict deck board movement. All drill torques are different so you should determine the proper setting for your drill. Also wood will have different densities so you should take that into account when determining your torque setting.

# TRUNORTHDECK

## End-To-End Spacing

Allow a minimum of 1/16" gap between board ends for every 6.6°C of difference between installation temperature and the hottest temperature expected (see Figure 1). Additional blocking may be needed for support (see Figure 2). Allow 1/4" distance between all material and any permanent structure or post. After all of the decking has been attached, snap chalk lines (white or yellow chalk recommended) flush with or up 1-1/2" out from the decking framing and trim with a circular saw. TruNorthDeck decking, like all other wood and composite decking products, requires proper ventilation and drainage in order to ensure its longevity. When using a minimum

2x6 joist standing on edge and the suggested 1/4" side gap, there should be a 2" clear space between the bottom and the edge of the joist

and grade to allow for proper ventilation. Adequate drainage is also needed to prevent water from pooling under the deck.

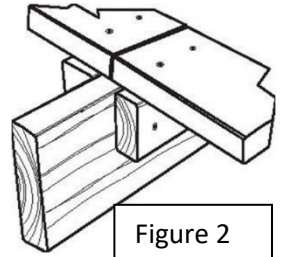

Figure 2

Figure 1

Board end to board end gapping requirements												
Temperature °C on day of installation	Warmest annual temperature °C expected in region											
	°C	-6.7	-1.1	4.4	10	15.6	21.1	26.7	32.2	37.8	43.3	48.9
	-6.6	1/8	1/8	1/8	1/8	1/8	3/16	3/16	1/4	1/4	5/16	5/16
	-1.1		1/8	1/8	1/8	1/8	1/8	3/16	3/16	1/4	1/4	5/16
	4.4			1/8	1/8	1/8	1/8	1/8	3/16	3/16	1/4	1/4
	10				1/8	1/8	1/8	1/8	1/8	3/16	3/16	1/4
	15.6					1/8	1/8	1/8	1/8	1/8	3/16	3/16
	21.1						1/8	1/8	1/8	1/8	1/8	3/16
	26.7							1/8	1/8	1/8	1/8	1/8
	32.2								1/8	1/8	1/8	1/8
	37.8									1/8	1/8	1/8
	43.3										1/8	1/8
	48.9											1/8

## Finishing (Figure 3)

Trim any excess by ripping the length of the board and predrill the board and secure the board to the joist by surface screwing with deck screws (hole plugs are not suggested for this side due to foot traffic), this will prevent the board from sliding out of the previous clip.

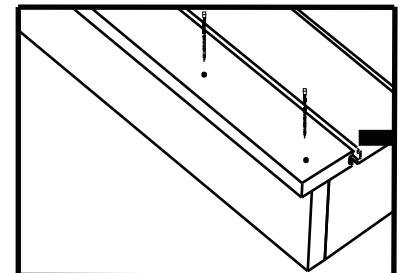

Figure 3

## Colour Variation

Like most composite TruNorthDeck Decking will have colour variations from piece to piece. Do not install if variation is not acceptable.

## Preventing mold and mildew growth on composite decking

Mold and mildew can be a nuisance on any exterior building surface, regardless of the material. If the conditions are right, they will spawn on the wood, plastic, concrete, metal and other surfaces. Mold formation is most prevalent in consistently wet, shaded areas. Spores from the natural environment are carried by the wind and commonly land on the deck surface. It is important to note that the appearance of mold/mildew is a function of nature, not necessarily a deficiency with any of the material on which it grows.

## Cleaning

Periodic washing with soap/detergent and water will help remove surface dirt. This will help to prevent the buildup of pollen, debris and spores the can cause and accelerate mold/mildew growth. Caution: A pressure washer should not be used to "blast" mold/mildew or soil from a deck surface. The abrasive nature of the water stream can potentially cause damage by driving the spores into the material, which may create a more challenging problem to remediate. A pressure washer with a fan-tipped nozzle should be used only to lightly wet or rinse the composite deck surface.

There are many deck wash and exterior cleaning products available at retail. It is important to make sure you use a cleaner specifically intended for your application. After selecting a product, be certain to read, understand and follow all instruction supplied by the manufacturer. Some cleaning products and inhibitors may be more effective than others, depending on the environmental conditions your deck is subjected to. Additionally, it is always a good idea to test the cleaner in a small, inconspicuous area prior to applying it to the entire deck.

### **Mold Inhibitors**

As with deck washes, there are several mold-inhibitor products available from paint store, hardware stores, online outlets and home centers to help prevent long-term mold/mildew growth. For any product selected, be certain to read, understand and follow all instructions provided by the manufacturer. Depending upon the environmental factors affecting your deck, some preventive cleaning products may be more effective than others. It may be necessary to try more than one product. For ongoing preventive maintenance, follow the manufacturer's recommendation.

---

TruNorthDeck decking is not suitable for structural use. It should not be used for primary load-bearing members such as posts, joists, beams or stringers. The same common-sense precautions should be taken when handling TruNorthDeck as with wood or other building materials. Dust mask and eye protection devices are recommended to avoid possible irritation from sawdust and chips. Gloves will help to protect the hands. Hands should be washed after doing construction work.

The diagrams and instructions in the brochure are for illustration purposes only and are not meant to replace a licensed professional. Any construction or use of the product must be in accordance with all local zoning and/or build codes. The consumer assumes all risks and liability associated with the construction or use of this product. The consumer or contractor should take all necessary steps to ensure the safety of everyone involved in the project, including, but not limited to, wearing the appropriate safety equipment. **EXCEPT AS CONTAINED IN THE WRITEN LIMITED WARRANTY, THE WARRANTOR DOES NOT PROVIDE ANY OTHER WARRANTY, EITHER EXPRESS OR IMPLIED, AND SHALL NOT BE LIABLE FOR ANY DAMAGES, INCLUDING CONSEQUENTIAL DAMAGES.**

2017 TruNorth Composites All rights reserved. TruNorthDeck is registered trademark of 2017 TruNorth CompositesLtd..

For more information visit us at [www.trunorthdeck.com](http://www.trunorthdeck.com)